



Nové symboly a značky súčiastok a meracích prístrojov v elektrotechnike :)

Obsah:

Základné značky 3
Súčiastky s PN-prechodom 6
Rezistory rôzne 4
Kondenzátory rôzne 4
Cievky rôzne 3
Spínače a Tlačidlá 10
Diódy rôzne 7
Meracie prístroje 6
Spracovanie zvuku 4
Zdroje napätia 6
Vodiče 3
Relé 4
Logické členy 13
Rôzne 6

K 29. máju 2023 sa v článku nachádza 76 značiek.

Základné značky

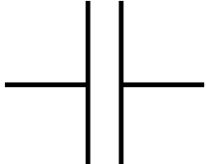
Názov	Značka
Rezistor	
Cievka	
Kondenzátor	

S PN-prechodom

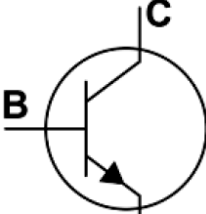
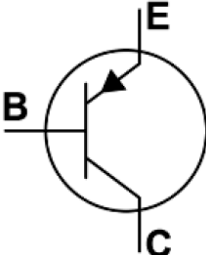
Názov	Značka
Dióda	
Tranzistor NPN	
Tranzistor PNP	

Tyristor



Diak

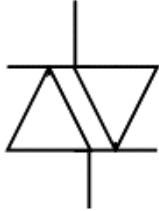

Triak

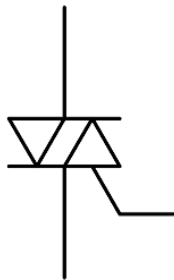

Rezistory rôzne

Názov

Značka

Rezistor

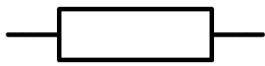

Potenciometer

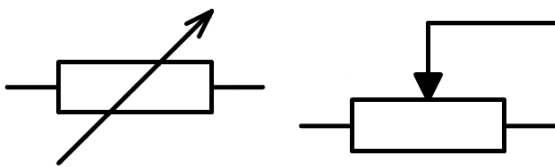

Trimer

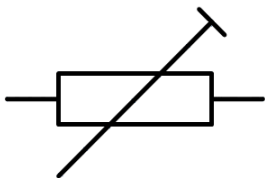

Kondenzátory rôzne

Názov

Značka

Kondenzátor

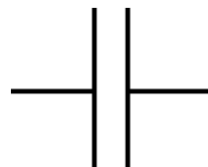

Elektrolytický kondenzátor

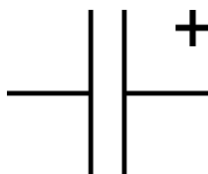

Nastaviteľný (ladiaci) kondenzátor



Dolaďovací kondenzátor

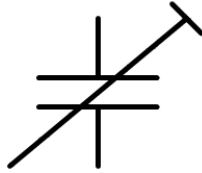

Cievky rôzne

Názov

Značka

Cievka vzduchová



Cievka so železným jadrom



Cievka s feritovým jadrom



Spínače a Tlačidlá

Názov

Značka

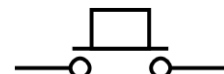
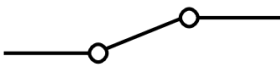
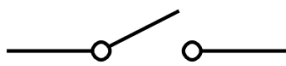

Spínače

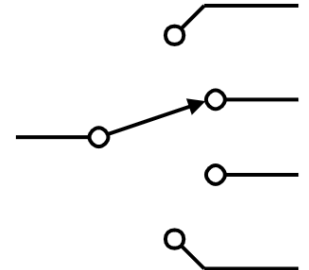
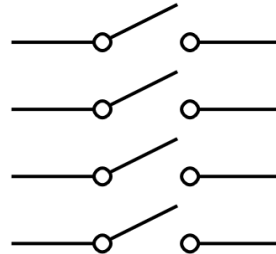
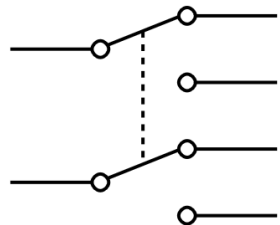
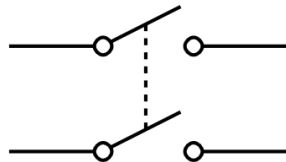

Tlačidlá

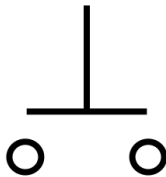

Diódy rôzne

Názov

Značka

Dióda



Polovodičová dióda



LED

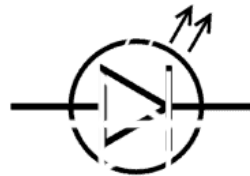

Fotodióda



Zenerova dióda (stabilizačná dióda)



Meracie prístroje

Názov

Značka

Ampérmeter	
Ohmmeter	
Voltmeter	
Osciloskop	
Galvanometer	

Spracovanie zvuku

Názov	Značka
Mikrofón	
Reproduktor	
Slúchadlo	
Zvonček	

Zdroje napätia

Názov	Značka
Transformátor	
Zdroj jednosmerneho napätia	
Zdroj striedavého napätia	
Článok batérie, monočlánok	
Batéria elektrických článkov	
Zem	

Vodiče

Názov	Značka
Vodič	

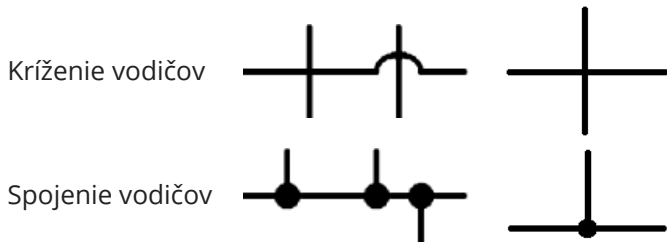

Relé

Názov

Značka

Bežné relé

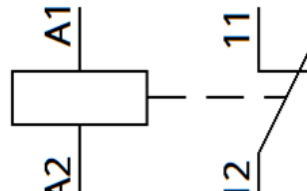

Relé s oneskorením odpadu

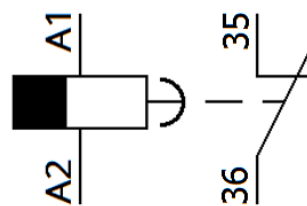

Relé s oneskorením prítahu

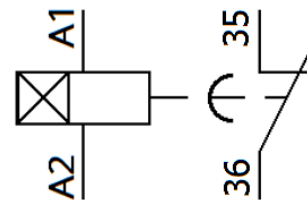

Elektronické počítadlo impulzov
(počítacie relé)

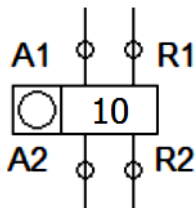

Logické členy

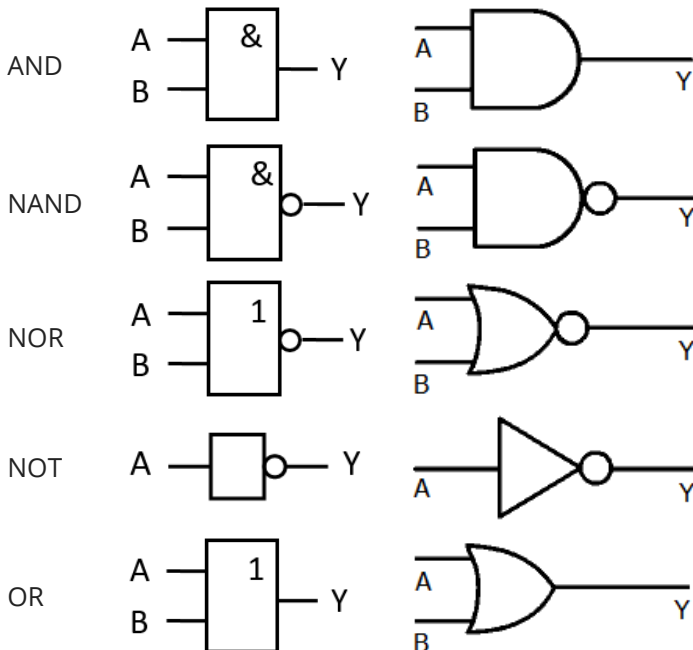

Názov

Značka

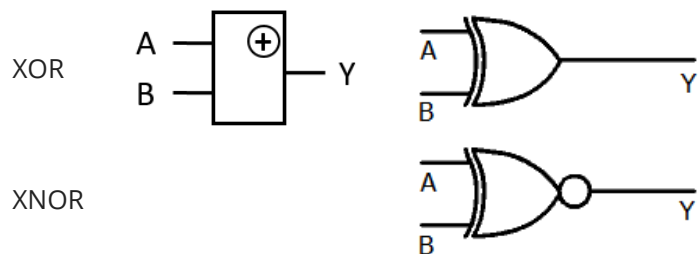

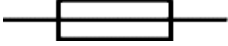
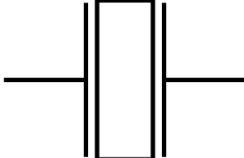

Rôzne

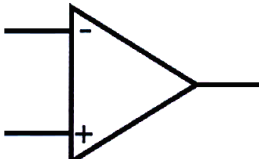
Názov	Značka
Anténa	
Poistka	
Kryštál (piezoelektrický rezonátor)	
Žiarovka	
Motor	
Operačný zosilňovač	



[Symboly a značky elektrotechnických schém](#)



- <https://byjus.com/physics/electric-circuit-electrical-symbols/>
- [Circuit Symbols](#)
- [Elektrotechnické značky používané ve schématech](#)
- [Jednoduché elektrické obvody Elektrické spotrebiče v domácnosti](#)
- [Elektrické symboly](#)