

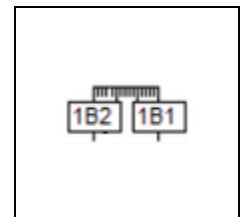

1. Vyberte súčiastky zapojenia.

Riešenie

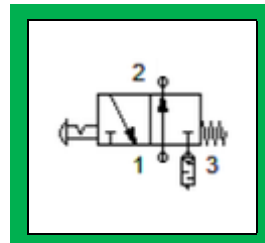
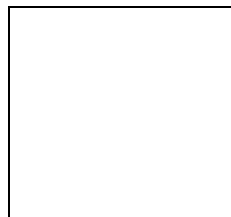
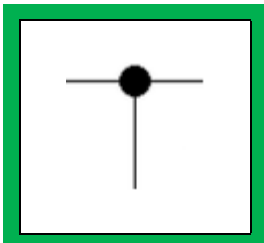
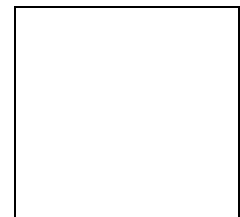
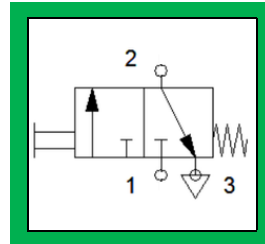
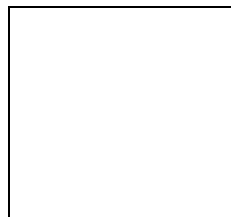
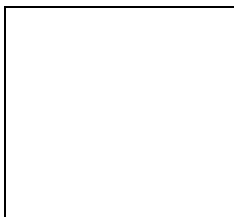
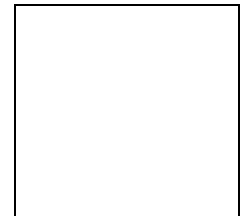
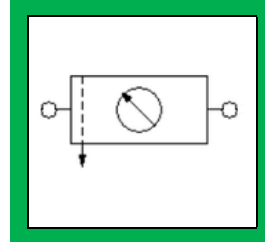
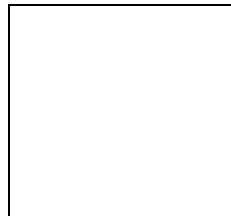
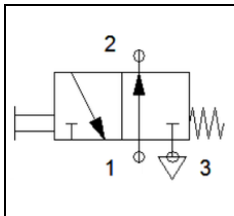
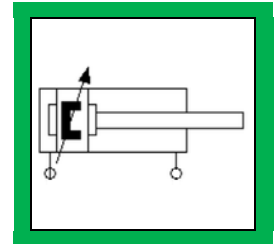
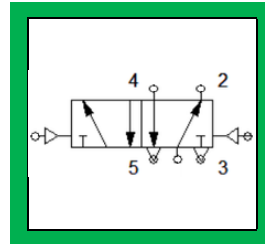
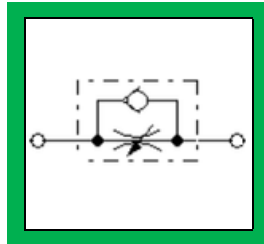
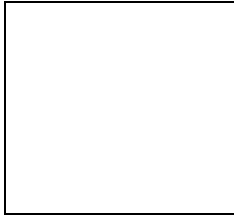
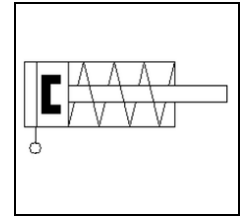
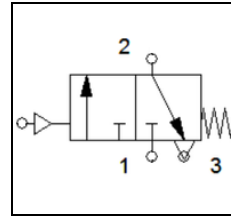
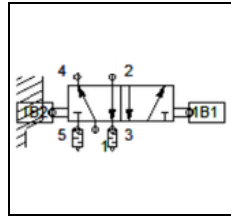
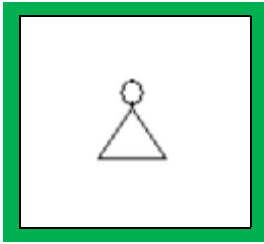

2. Súčiastky rozmiestnené na ploche vhodne pospájate/Vytvorte schému zapojenia.

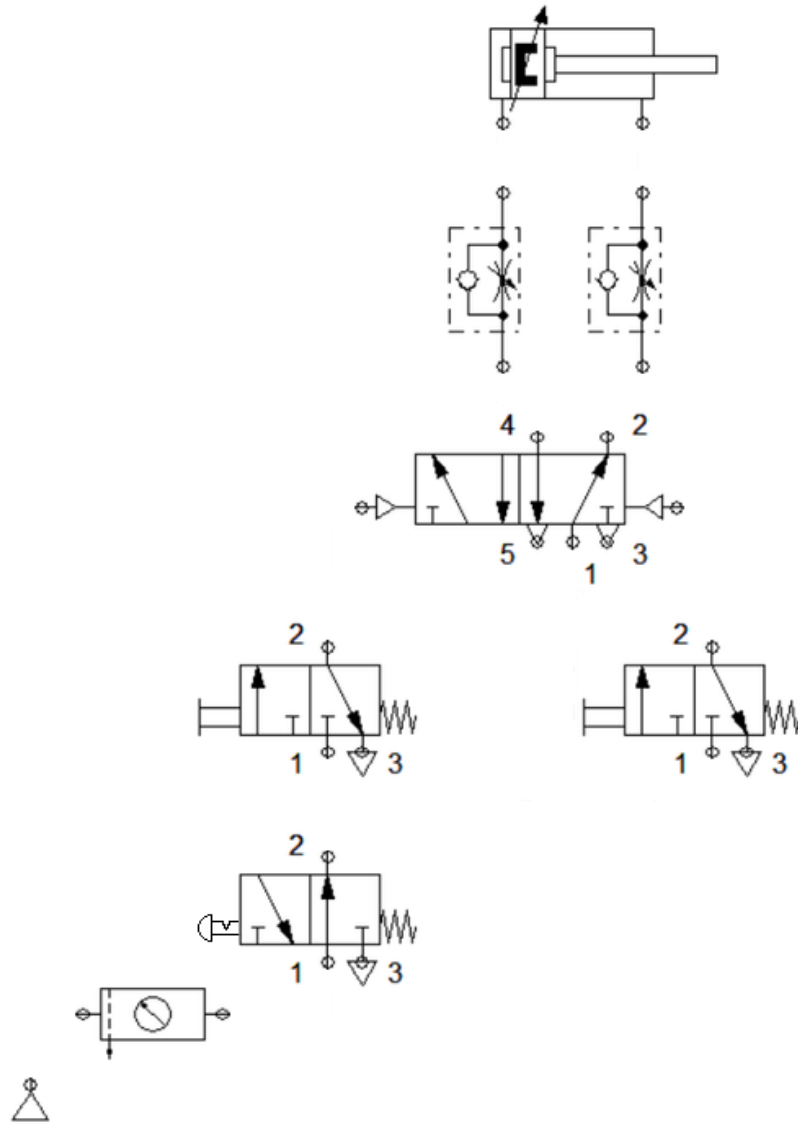

2. Súčiastky rozmiestnené na ploche vhodne pospájate/Vytvorte schému zapojenia.  
Riešenie

